

Article number: 201578280

Description: E+G Handwheel
GN 950.6-100-B10-F

Measures

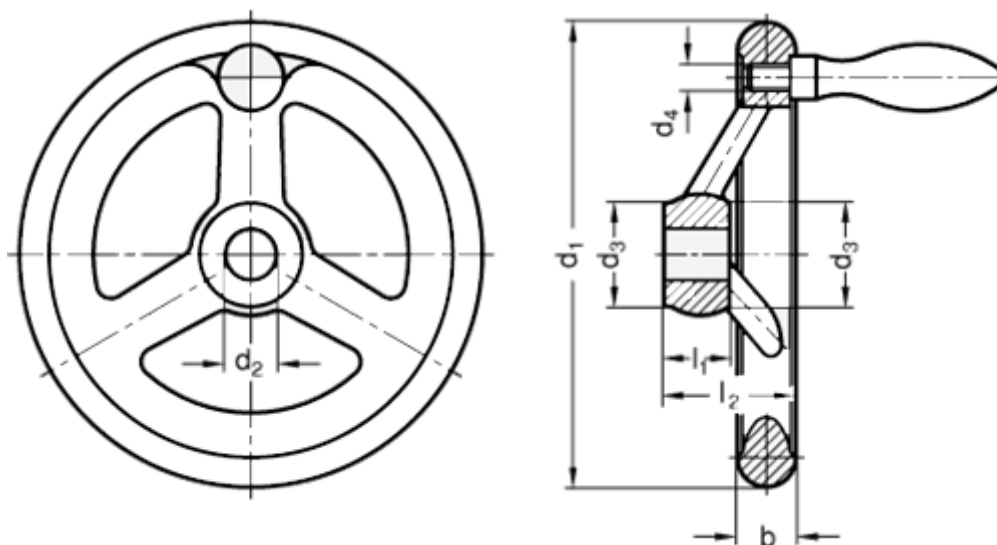

$b_1 = 14.5$

$d_1 = 100$

$d_2 = 10$

$d_3 = 25.5$

$d_4 = M6$

$l_1 = 17$

$l_2 = 33.0$